

Presented by:



Syntellix AG
Schiffgraben 11
30159 Hannover
Germany

T +49 511 270 413 50
F +49 511 270 413 79

info@syntellix.com
www.syntellix.com

Implants are manufactured in Germany
in cooperation with Königsee Implantate GmbH.

CE 0197

7020.001.001 08/15

Intelligent innovations for a better life.



CAUTION

This product description is not sufficient or adequate to allow immediate use of the instruments and the implant described. Instruction must be given by authorized personnel prior to use of these instruments and implants!

Since the implants are designed for single use only, reuse of MAGNEZIX® implant devices is grossly negligent and can result in an increased risk of infection and loss in implant stability. In general, re-sterilization alters the implant's functionality in an unpredictable way.

In the case of concurrent use of third party implants it must borne in mind that steel, titanium and cobalt-chromium alloys may not remain in direct contact with a MAGNEZIX® implant at the intervention site (i.e. no physical contact of implants).

The image shown on the frontispiece is a CAD image. The actual implant may differ in appearance.

INTRODUCTION..... 04

THE MATERIAL MAGNEZIX® 04

INTENDED USE 06

INDICATIONS..... 06

CONTRAINDICATIONS 06

WARNINGS 06

ADVANTAGES AND FEATURES..... 08

SURGICAL TECHNIQUE..... 10

PRODUCT OVERVIEW..... 16

IMPLANTS 16

INSTRUMENTS 17

MAGNEZIX®

THE MATERIAL MAGNEZIX®

MAGNEZIX® is the name given to the world's first bioabsorbable implant material: it is a metallic alloy that has a CE Mark approval for medical applications within Europe.

MAGNEZIX® is a magnesium-based alloy with the properties of a metal but which is nonetheless fully absorbable in the body where it is replaced by body-own tissue. The biomechanical properties of MAGNEZIX® are very similar to those of human bone. Some studies have also demonstrated that magnesium alloys have osteoconductive¹ properties.

Advantages for Users and Patients

- Complete bioabsorption of the implant makes later removal of the product obsolete.
- The mechanical properties are significantly better than those of conventional resorbable implants.
- The implant is completely and homogenously transformed into body-own tissue.
- Histological investigations show bone formation at the implant's surface and bone growth into previously bioabsorbed implant sites.
- The use of MAGNEZIX® implants does not lead to so-called „stress shielding“ (bone degradation) due to bone-like biomechanical properties.
- In terms of applicability, MAGNEZIX® implants hardly differ from conventional implants made of steel or titanium. This is ensured by the adapted design, which takes the material and bioabsorbable properties into account.
- MAGNEZIX® implants are visible radiographically, MR conditional and do cause marginal artifacts only (please refer to the Instructions for Use).

1 Revell et al. (2004) The effect of magnesium ions on bone bonding to hydroxyapatite coating on titanium alloy implants. Key Eng Mater Vol. 254-256, 447-50.

Liu et al. (1988) Magnesium directly stimulates osteoblast proliferation. J Bone Miner Res (3), 104.
Zreiqat et al. (2002) Mechanisms of magnesium-stimulated adhesion of osteoblastic cells to commonly used orthopaedic implants. J Biomed Mater Res 62 (2), 175-84.

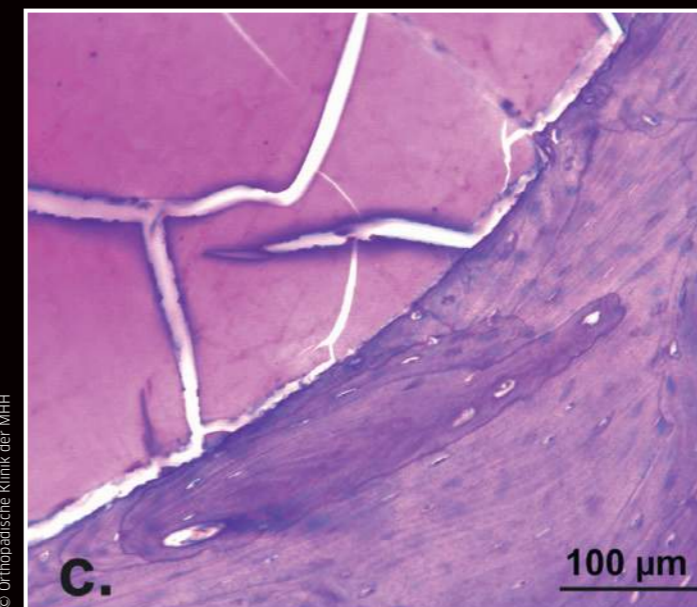
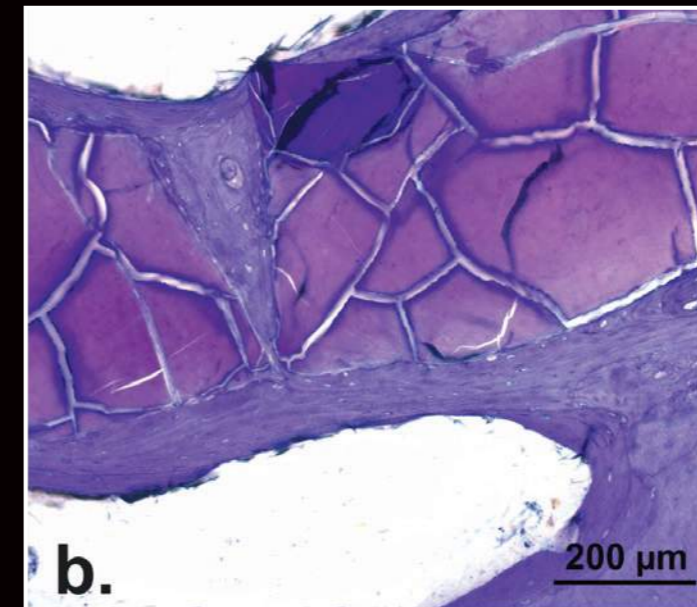
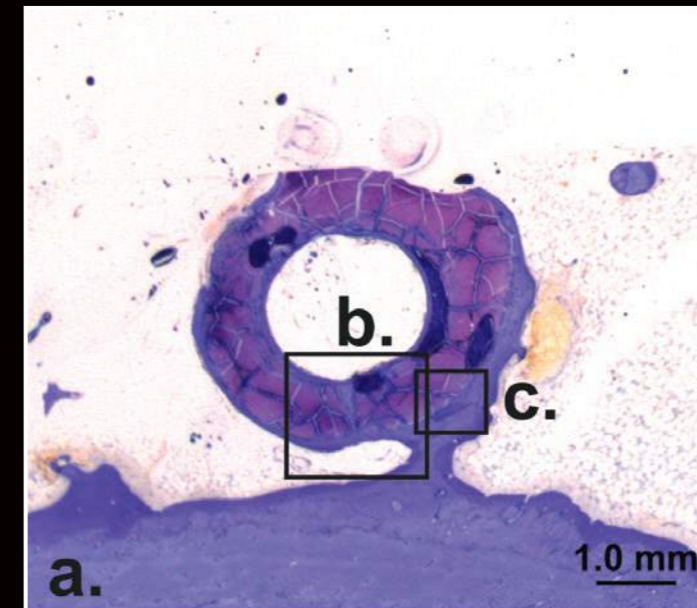

Figure left:
Histological evaluations in an animal study verified full and complete transformation of the metallic implant after a 12-month implant period. Studies demonstrated new bone formation with direct implant contact and presence of osteoblasts and osteoclasts.

Introduction**INTENDED USE**

MAGNEZIX® CS bioabsorbable compression screws serve the purpose of re-establishing bone continuity after fractures and osteotomies (osteosynthesis) as well as for treatment of pseudarthroses (re-osteotomies). The objective when using the MAGNEZIX® CS device is specifically anatomic retention by way of surgical splinting of assembled bone fractions after prior repositioning until bony healing. The implants are designed for single use only.

INDICATIONS

The indications for MAGNEZIX® CS implants are reconstructive procedures after fractures, malpositions and/or other pathological bone alterations of the human skeleton. The surgeon must in all cases determine the extent of the injuries or the bony alterations and the scope of the necessary surgical intervention and select the appropriate operating procedure and the appropriate implant. This applies in particular when using bioabsorbable MAGNEZIX® implants. The surgeon is always responsible for the decision to use the implant.

According to its respective dimension, MAGNEZIX® CS can be used for adaption- and exercise-stable fixation of bones and bone fragments in children, adolescents and adult persons. Relevant medical literature and guidelines must be observed when determining the dimensions of screws to be used.

The MAGNEZIX® CS 2.0 is for example suitable for the following:

- Intra-articular and extra-articular fractures of small bones and bony fragments
- Arthrodeses, osteotomies and pseudarthroses of small bones and joints
- Small bony avulsions of ligaments and tendons

Including:

- Phalanges, metacarpalia
- Processus styloideus radii et ulnae
- Capitulum and caput radii
- Osteochondrosis dissecans

CONTRAINDICATIONS

In specific clinical situations the use of MAGNEZIX® implants may be prohibited (absolute contraindication) or use may be planned subject to certain considerations (relative contraindication).

Absolute contraindications

- Insufficient bone substance to anchor the implant
- Evidence or suspicion of septic-infectious operating area
- Known allergies and/or known foreign body reactions
- Application in the area of the epiphyseal plates
- Load-stable osteosyntheses
- Arthrodeses of medium-sized and large joints
- Use in the spinal column

Relative contraindications

- Options for conservative treatment
- Acute sepsis
- Osteoporosis
- Alcohol and/or drug misuse
- Epilepsy
- Limited skin/soft tissue conditions
- Non co-operative patient or limited mental state of patient
- No possibility for providing adequate post-operative follow-up (e.g. temporary load relief)

Warnings

In the case of concurrent use of third party implants it must borne in mind that steel, titanium and cobalt-chromium alloys may not remain in direct contact with a MAGNEZIX® implant at the intervention site (i.e. no physical contact of implants).

Since the implants are designed for single use only, reuse of MAGNEZIX® implant devices is grossly negligent and can result in an increased risk of infection and loss in implant stability. In general, resterilization alters the implant's functionality in an unpredictable way.



ADVANTAGES AND FEATURES

BIOABSORBABLE MAGNESIUM ALLOY

The use of MAGNEZIX® makes subsequent removal of the implant obsolete: furthermore MAGNEZIX® promotes the bone healing process. MAGNEZIX® is bioabsorbable, biocompatible and non-toxic in a biological environment.

The use of the innovative bioabsorbable MAGNEZIX® metal alloy allows the screw to be implanted using standard techniques.

Self-tapping screw tip

The self-tapping properties of the screw tip reduce the operation time and simplify the surgical application technique.

Self-tapping head thread

The self-tapping design of the screw head simplifies insertion and countersinking of the screw head.

Different thread pitches

The threads of the head and the shaft have different thread pitches. This adapted design of the screw generates compressive forces and supports the intended interfragmentary compression.

Self-holding screwdriver

The head of the screw is of T4 (ISO 10664-4) design. The advantages of this ISO standardized technology are:

- Enlarged contact area
- Improved self-retaining mechanism
- Improved torque transmission

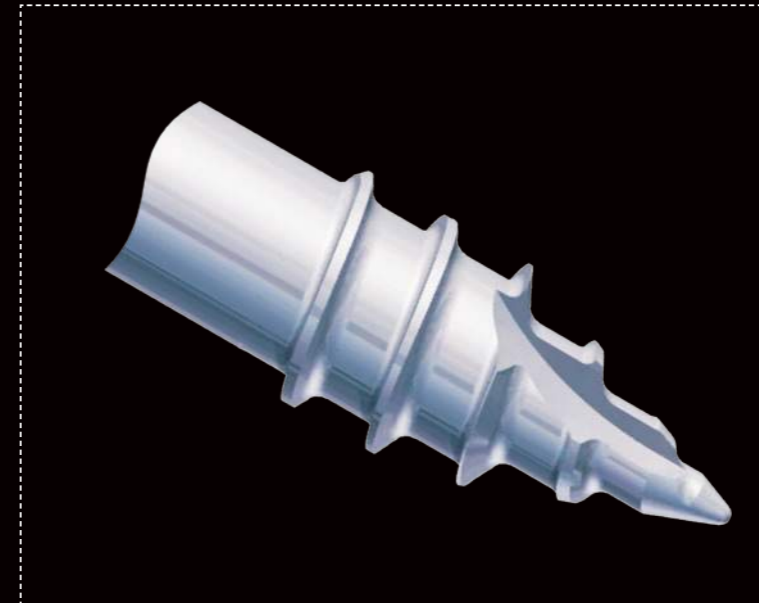

SURGICAL TECHNIQUE

SURGICAL TECHNIQUE MAGNEZIX® CS – STEP BY STEP

Prior to implanting a MAGNEZIX® CS 2.0 screw it is necessary to ensure repositioning and temporary stabilization of the fracture or the osteotomy.

Although the MAGNEZIX® CS 2.0 screw has a self-cutting tip, a pilot hole must always be predrilled. The pilot hole also allows precise selection of the correct screw length.

Step 1: Drilling the pilot hole

Position the double drill guide through the soft tissue to the bone. Insert the drill bit through the double drill guide and into the bone, possibly monitoring with the image intensifier until it is at the required depth.

Important

If no pilot hole is drilled, the precise screw length cannot be correctly determined. Pre-drilling with an incorrect alignment can lead to malfunction of the screw.

Instruments used:

- ① 9020.033 Double Drill Guide, Ø 2.2/1.5 mm
- ① 9020.020 Drill Bit, Ø 1.5 mm

Step 2: Determination of screw length

The length of the screw is determined by means of the depth gauge to determine the depth of the pre-drilled pilot hole in the bone. (18 mm in the figure).

Important

When selecting the length of the screw one has to ensure proper compression of the fracture gap.

Instruments used:

- ③ 9020.042 Depth gauge for screws

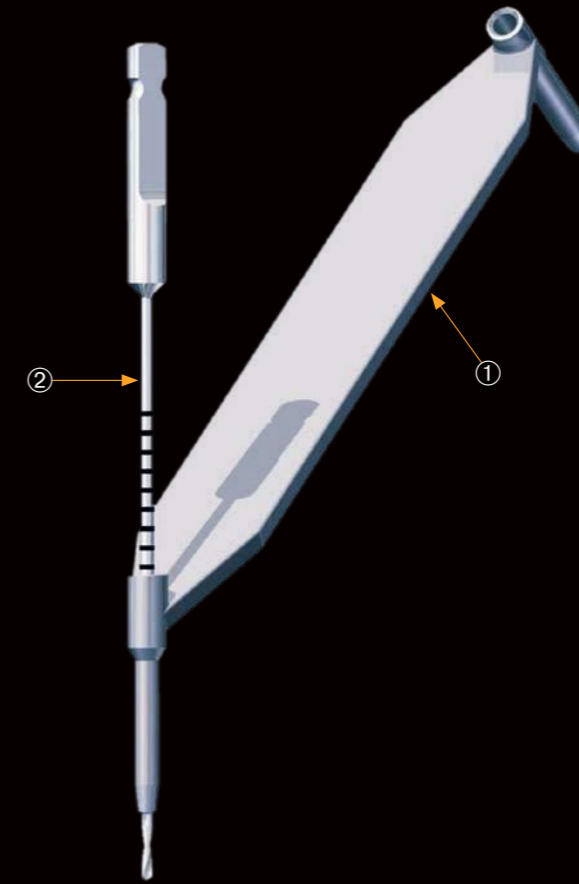

STEP 1

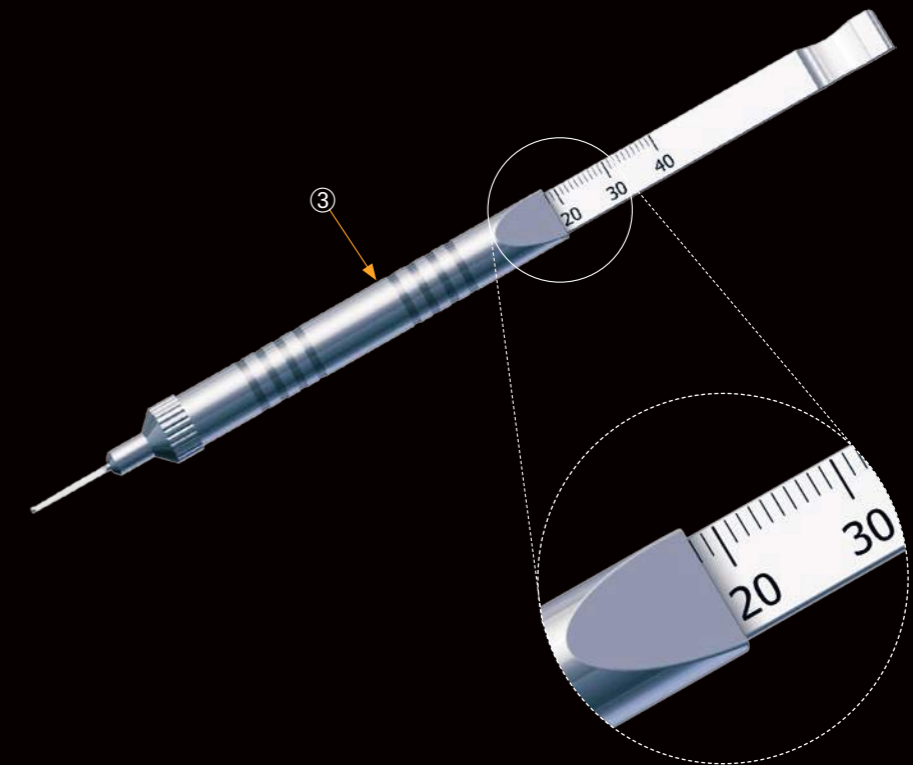

STEP 2

Step 3: Countersinking

In order to simplify insertion of the screw head the head-side of the intended implant position is now reamed using the countersink.

Important

If the screw is positioned perpendicular to the bone surface, countersinking to the first ring marking (RM1) is required in order to achieve adequate countersinking of the screw head.

If the screw is positioned at an angle of 45° to the bone surface, countersinking to the second ring marking (RM2) is required in order to achieve adequate countersinking of the screw head.

Instruments used:

- ① 9020.033 Double Drill Guide, Ø 2.2/1.5 mm
- ② 9020.021 Countersink Ø 2.2/1.5 mm, for Quick Coupling

STEP 3

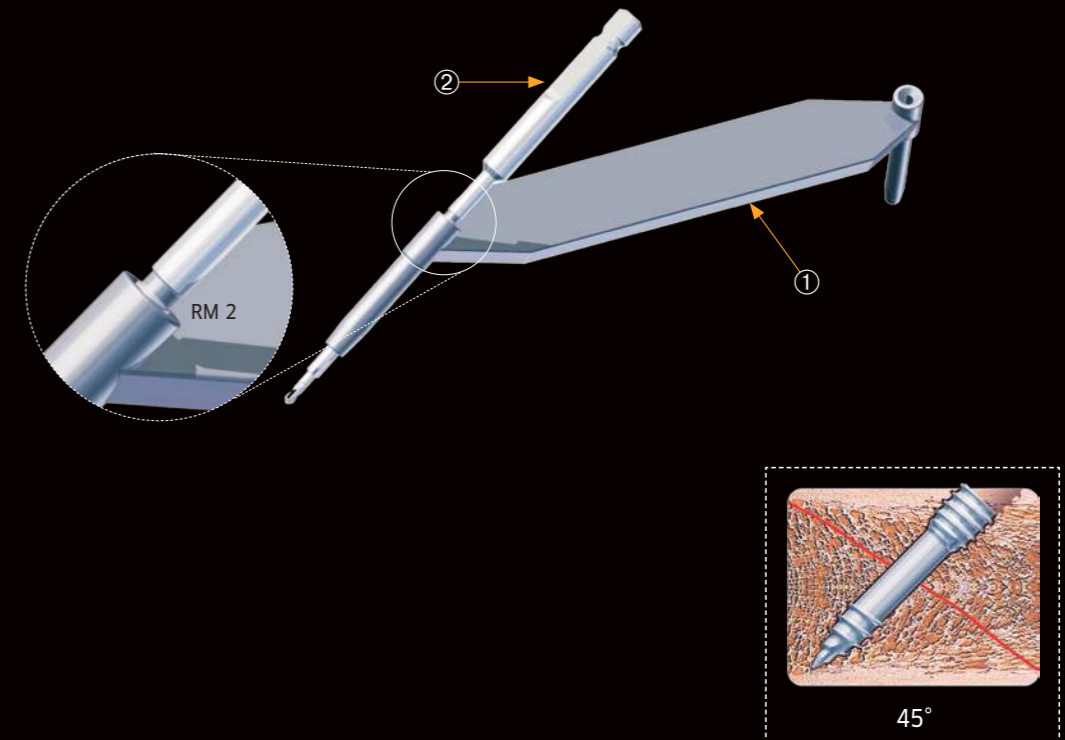
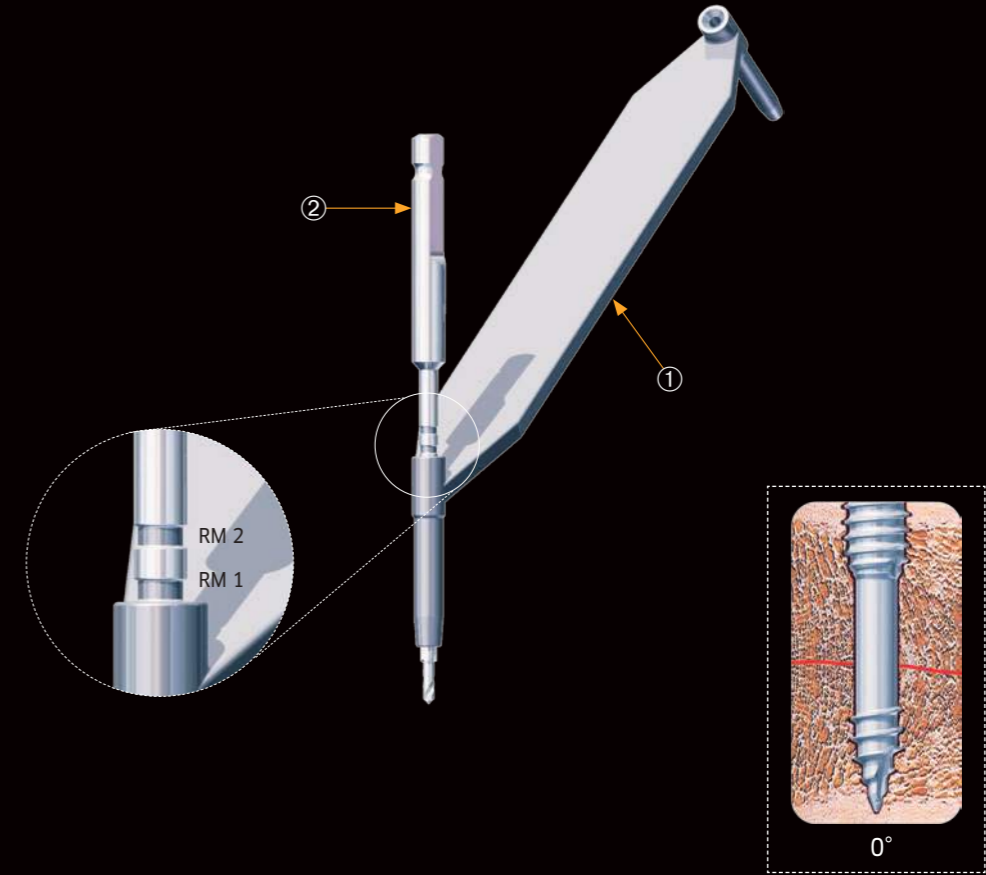

Step 4: Inserting the screw

The MAGNEZIX® Compression Screw 2.0 of the previously determined length (step 2) is now screwed into place.

Important

Bear in mind that the shaft thread could pull out of the distal bone fragment if the induced compression forces when screwing-in the screw are excessive.

If the selected screw is too short the shaft thread might cross the fracture or osteotomy gap. If this situation results no compression will be generated. Therefore, to ensure the correct position of the threaded shaft it is recommended to check the position using an image intensifier.

If one finds the thread crossing the fracture or osteotomy gap the screw must be removed and a longer screw has to be selected in order to generate compression. When doing this and in the case of a hard (dense) bone situation, it might be necessary to repeat the pre-drilling process as described in step 1 to further deepen the pre-drilled pilot hole for the selected screw with an adequate length.

Instruments used

① 6020.104 Screwdriver T4, One-Piece Handle

Optional

6020.204 Screwdriver T4, Multi-Part Handle

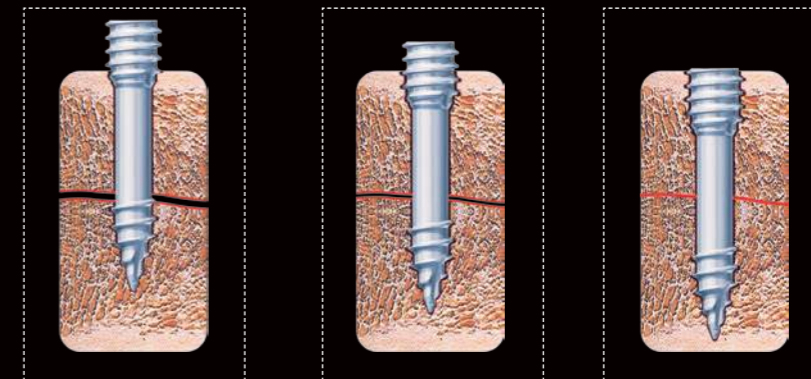
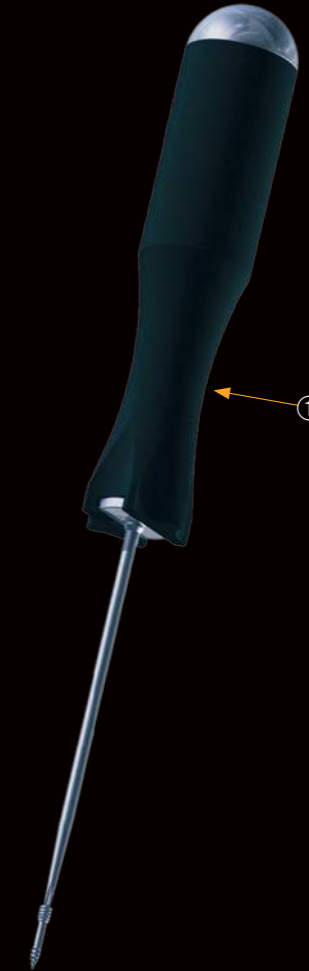
STEP 4

MAGNEZIX® CS 2.0 IMPLANTS

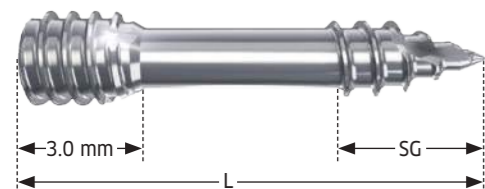

Art. No.	Threaded shaft length [mm] SG	Screw length [mm] L
1020.008	4	8
1020.010	4	10
1020.012	4	12
1020.014	5	14
1020.016	5	16
1020.018	5	18
1020.020	6	20
1020.022	6	22
1020.024	6	24

All implants are individually sterile packaged.
It is not possible to re-sterilize the implants.

MAGNEZIX® CS 2.0 INSTRUMENTS*

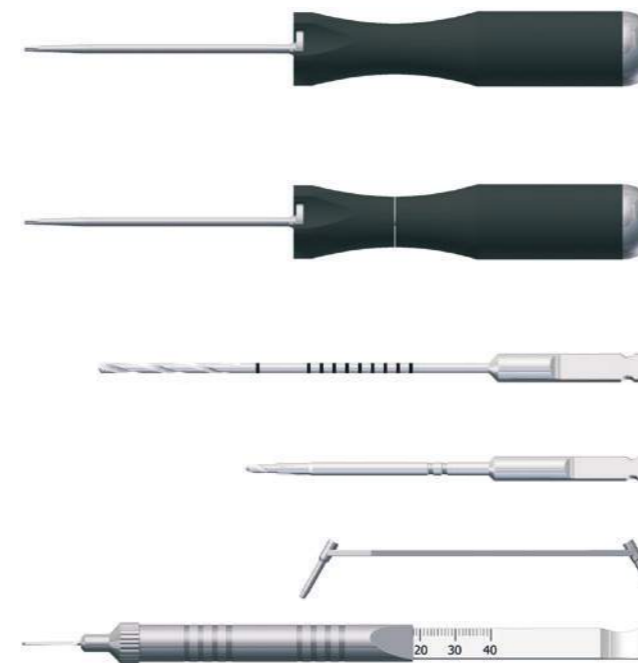

Art. No.	Description
6020.104	Screwdriver T4, One-Piece Handle, consisting of: 9099.001 One-Piece Handle for Screwdriver 9020.015 Screwdriver Blade T4
6020.204	Screwdriver T4, Multi-Part Handle, consisting of: 9099.002 Multi-Part Handle for Screwdriver 9020.015 Screwdriver Blade T4
9020.020	Drill Bit Ø 1.5 mm, length 88/63 mm, for quick coupling
9020.021	Countersink Ø 2.2/1.5 mm, for quick coupling
9020.033	Double Drill Guide, Ø 2.2/1.5 mm
9020.042	Depth gauge for screws
Not shown:	
8020.001	Sterilizing Tray for MAGNEZIX® CS Ø 2.0 mm, without contents
8020.002	Lid for Sterilizing Tray, for MAGNEZIX® CS Ø 2.0 mm

*The figures are not to scale.

METALLIC AND
BIOABSORBABLE.
A MEDICAL SENSATION.
MAGNEZIX®

